



STILGRAFIC



*Consumables De l'arte Graphique
Vente machines*

*Consumibles de Artes Graficas
Venta de Maquinaria*

STILGRAFIC

Catalog

P 3-4 Cylinder & Valve

P 4-10 Motor Sensor Fan Blower
Board Display & Pump

P 11 Suction Tape & Belt

P 12-13 Switch Encode & Button

P 14 Gripper & Gripper pad

P 15 Filter Blanket & Grease

P 16-17 Repair tools & Oils

P 18 Underpaper & washup-cloth

P 19-20 Feederparts & roller brush

P 21-22 Sucker Camfollower

P 23 Gripper bar





P 24-28 Printing unit accessories

P 29 Special Recommendation





P 30-35 Postpress Equipment accessories







STILGRAFIC





				
00. 580. 1103	00. 580. 2291	00. 580. 3387/03	00. 580. 3909/02	00. 580. 3385





				
00. 580. 4034	00. 580. 4101	00. 580. 4127	00. 580. 4275	00. 580. 4300

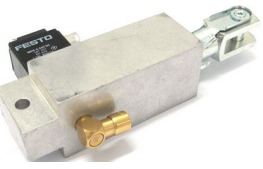



				
00. 580. 4615	61. 184. 1131	61. 184. 1133	61. 184. 1141	61. 184. 1151



				
61. 184. 1191	61. 184. 1331	61. 184. 1101	61. 335. 001	81. 034. 004/01





				
87. 334. 001	87. 334. 002	87. 334. 005	87. 334. 011	87. 334. 014

				
87.334.018	61.184.1051	98.184.1051	92.184.1011/A	92.184.1001/A

				
G2.334.010	F7.335.001	F2.335.001	F4.335.135	G2.335.159

				
G4.334.004	G2.335.092/093	G2.184.0040	H2.335.001	L2.334.004/01

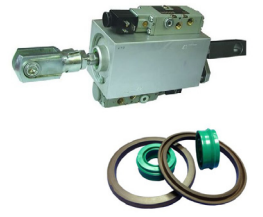

				
L2.335.051/01	M2.184.1111/1121	M2.184.1131	M2.184.1141	M2.184.1071

				
M2.184.1091	M2.184.1171	M2.184.1051	M2.184.1011	S9.184.1051

				
61. 144. 1121	61. 144. 1141	61. 144. 1161	L2. 105. 1311/02	G2. 144. 1141



				
R2. 144. 1121	71. 186. 5121	61. 144. 1101	71. 186. 5311	61. 186. 5311

				
61. 186. 5411	61. 186. 5511	61. 144. 1111	F2. 110. 1463	G2. 110. 1461

				
68. 110. 1322	91. 165. 1521	93. 110. 1331	91. 110. 1321	H2. 110. 1612

				
M2. 198. 1563.	L2. 110. 1563	61. 198. 1553	61. 198. 1563	00. 783. 0799

STILGRAFIC

				
F2. 161. 1421/02	M5. 122. 1311/05	61. 110. 1381/02	9E. 110. 2571	G4. 101. 2003/01



				
L2. 105. 1012/03	MOT00. 785. 0370/01	HAK 00. 785. 0749	00. 785. 1475/02	00. 785. 1613





				
00. 785. 1438/03	R2. 126. 1501/02	92. 161. 1531/A	98. 105. 1211/A	M5. 105. 0311

				
CP2000 display	Touch screen	71. 102. 8942	61. 110. 1321	L4. 196. 1826





				
00. 783. 0841	UPS	00. 785. 0404/04	98. 179. 1911	R2. 179. 1911

STILGRAFIC

				
F2. 115. 2521	61. 115. 2501	71. 196. 1516	81. 179. 1911	FS. 102. 3501





				
GNT6029183P1	00. 783. 082	1428. 072. 008	93. 031. 001	00. 580. 3869

				
MYH-5/2-M5-L-LED	61. 101. 1021	00. 783. 0477	M2. 161. 1533	61. 110. 1711



				
91. 110. 1321/A	63. 196. 1756	L2. 110. 1381	F2. 110. 1311	00. 783. 0139



				
SOR	00. 783. 0388A	C2. 122. 1311	C2. 196. 1676	C4. 110. 1321

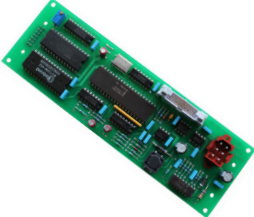
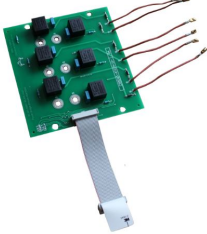

STILGRAFIC

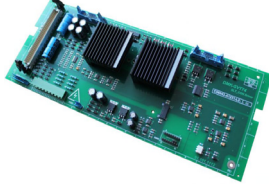
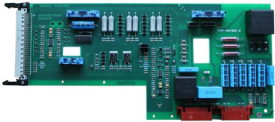
				
C6. 302. 502	ZA3. 26661	00. 783. 0670	L2. 110. 1441/03	00. 783. 0477

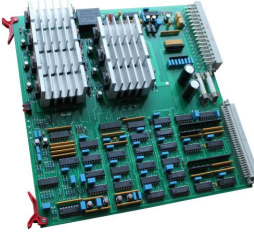
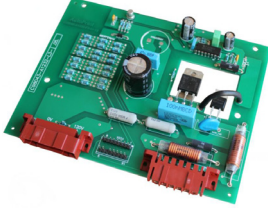
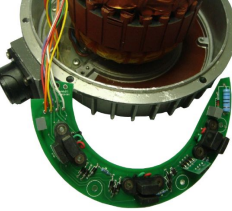
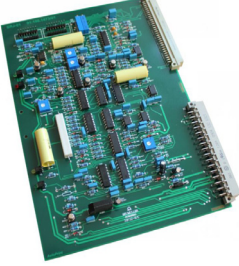
				
211098	Water tank battery	ATO-02-1-I-SOND916	4M. 144. 9116	LTK500

				
MID display	53. 101. 1122	61. 105. 1031	91. 101. 1112	91. 101. 1141





				
91. 144. 8021/01A	M0 / SM74 SVT	61. 198. 1243	91. 198. 1473	GRM 00. 785. 0518

				
61. 101. 1121	91. 144. 8011/02B	EAK	00. 785. 1310/04	00. 785. 1121

STILGRAFIC

				
00. 783. 0182/04	00. 783. 1287	91. 147. 1441	00. 785. 1528/1529	10. 107. 3199/02





				
10. 115. 6299	00. 785. 3184	00. 782. 0695	00. 785. 0224	MV. 036. 387



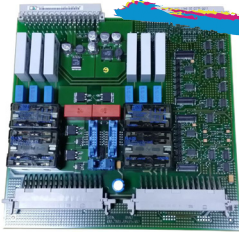

				
HE24/HE25	M2. 184. 1051	L2. 105. 3061	G2. 144. 7011	81. 186. 5151



				
81. 186. 5141	61. 144. 1131	71. 144. 5311	F2. 179. 2111/06	L2. 179. 1051



				
G2. 144. 5031	61. 105. 1943	F2. 105. 1171	M2. 179. 1911	M2. 105. 3311/1311



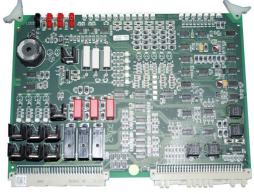
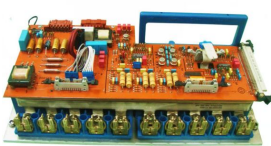
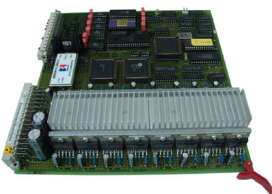

STILGRAFIC

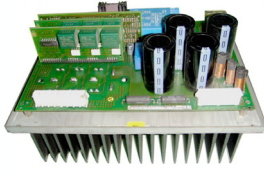
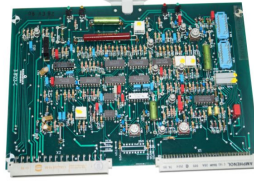
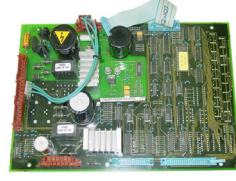
				
00. 785. 0311/1311	00. 785. 1364	00. 785. 1297. 1	NT85 Power	00. 785. 0392

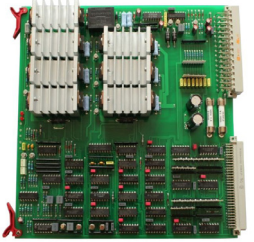

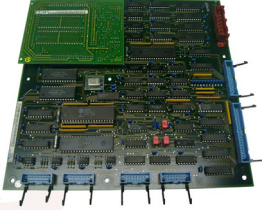
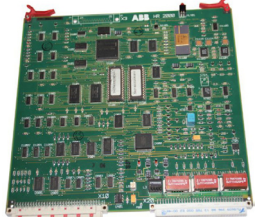

				
10. 118. 4299	10. 114. 3899	00. 785. 0382/02	81. 186. 5385	00. 785. 0354/0382

				
ZA3. 063962R	ZA3. 434861R	SVT 102/M0/74	00. 785. 0118/0405	00. 785. 0702

				
M2. 144. 2111	91. 198. 1473	00. 781. 1267/02	polar ZA3. 040164	91. 144. 8021

				
SPK	00. 785. 0215	00. 781. 2193	SRK	61. 110. 1341/SUM1

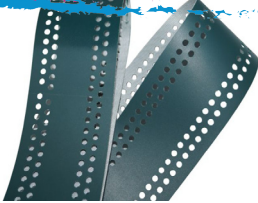



STILGRAFIC

				
F4. 020. 292/02	L2. 020. 014	M3. 020. 014	G2. 020. 009	M2. 020. 018





				
M2. 015. 870	F4. 614. 831	F4. 614. 821	M2. 015. 880	C3. 015. 453





				
M2. 015. 898F	M2. 015. 357/01	M2. 015. 843F	F4. 614. 881F	F4. 614. 560/01

				
M2. 015. 878	F4. 514. 578	MV. 051. 156	S5M-435	00. 780. 0475

				
00. 580. 5587	T5-200	G2. 072. 087	86. 020. 029	242590



STILGRAFIC

				
91. 110. 1381	C2. 101. 3013/01	63. 101. 2211	00. 250. 0970	M2. 110. 2571/02





				
L4. 110. 1235	287-523-01-00	M2. 179. 1911	00. 780. 1768	00. 780. 1329

				
MV. 057. 334	71. 186. 5172	L6. 170. 0807	F2. 110. 1331	A4. 164. 1710

				
FH. 1261351	92. 112. 1311	00. 780. 0191	00. 250. 1053/03	H2. 109. 1321

				
00. 780. 1326	L2. 110. 1495	F2. 115. 2441	F2. 018. 220/05B	L4. 196. 1748

				
00. 783. 0675	G2. 110. 1392	A1. 144. 9134	A1. 144. 9129	71. 186. 4421





				
81. 186. 3815	81. 186. 3855	Contact button	SM52 button	MV. 051. 057

				
MV. 051. 053	MV. 051. 054	MV. 051. 081	MV. 051. 057	MV. 051. 051

				
00. 580. 3994	00. 580. 3999	00. 780. 2321	00. 780. 2320	00. 780. 1786

				
MV. 051. 082	00. 780. 2491	00. 780. 1786	00. 783. 0632	416716

STILGRAFIC

				
C3. 011. 627	C3. 011. 920	79. 580. 637	91. 580. 637	C3. 581. 920





				
91. 581. 020	63. 014. 024	93. 525. 310	M4. 011. 727	A4. 011. 035





				
A4. 014. 022	C4. 313. 107	G2. 014. 018S	09. 014. 036	F2. 011. 108

				
MV. 102. 008	69. 011. 727F	52. 580. 363	93. 014. 307	53. 005. 208

				
M2. 581. 727/06	SA. 313. 195	61. 580. 727	49. 011. 027	M2. 013. 025

STILGRAFIE

				
66.024.012	super bull	Kinfe	Ink Knifes	Saphira Blanket





				
FS.102.3801/01	00.580.5832	F3.102.1522	L6.187.2125/01	66.028.403





				
47.018.106	00.580.6164	00.580.5379	00.580.1558	00.580.4992/01

				
00.472.0060	63.102.2061	91.714.604F/01	63.196.1811	00.580.4702/01



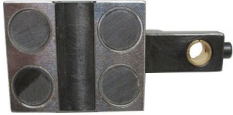

				
C6.432.252	00.580.1432	00.580.1518	63.196.1911	DS.196.2015/02





STILGRAFIE

				
MAGNIFYING	Ink Repellent	PANTONE	Parallel Pin Punch	00. 520. 2798

				
BV. 005. 7272/02	71. 102. 1923	71. 102. 1924	bottles	grease

				
G2. 207. 011N	M2. 033. 061S/03	00. 472. 0006	00. 580. 1010	Stitching wire





				
82. 806. 801	66. 024. 001	91. 008. 044/A	Anti-markingPaper	GLUE



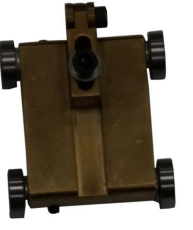

				
clean brush	H2. 007. 129/03	66. 353. 011	42. 024. 005	G2. 164. 1713





STILGRAFIC

				
oil	00. 580. 7972	GP150/00. 580. 7973	PS Hole puncher	93. 021. 026F

				
ink duct film	00. 580. 7407	LA8	LA8P	add PS pen

				
adjust gripper tool	Dampening roller cover	Drills	Bonders	93. 205. 516/B

				
LAMP 7W / 5W	00. 580. 4457	Pin puller tools	carbon	Thickness Gauge

				
Mould feeler gauge	ZD. 400-072-0200	MV. 025. 468/06	clean paste	Fount EX

STILGRAFIC

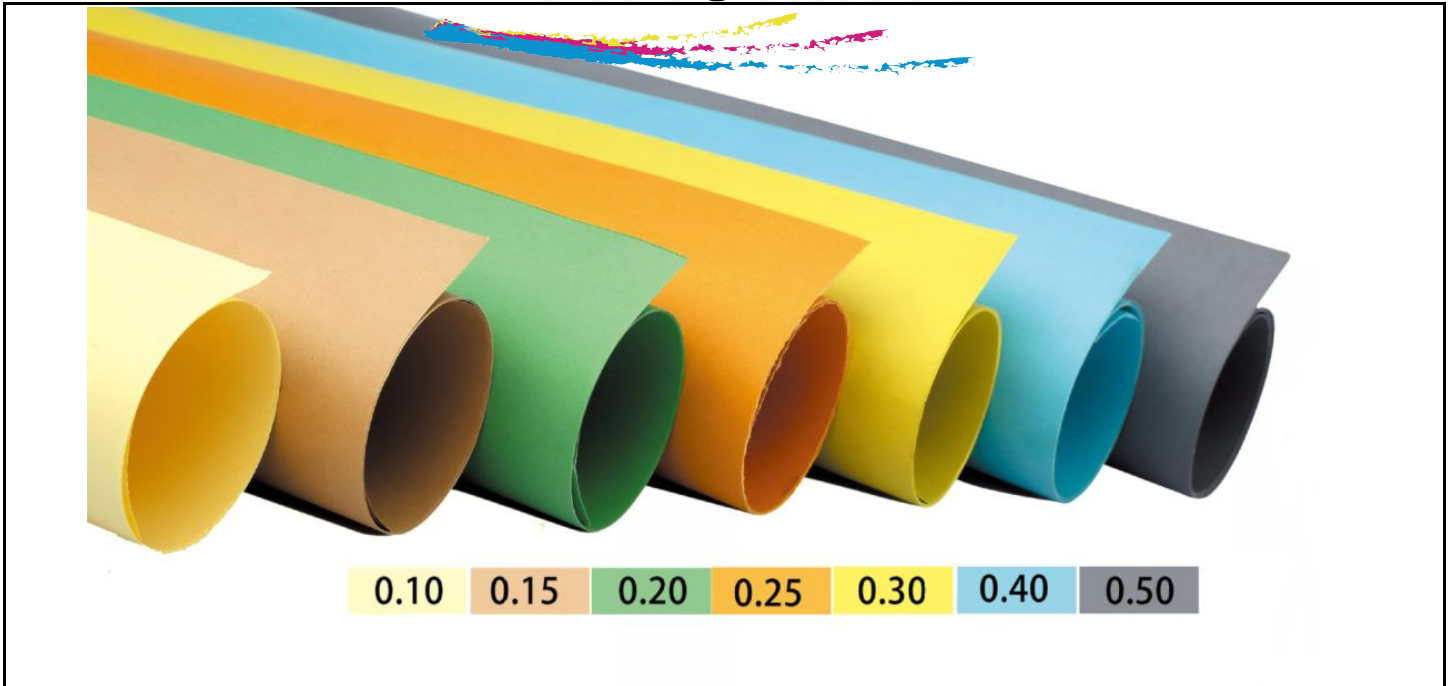

Underpacking paper for under the offset impression cylinder (Tickness Sheetsize)

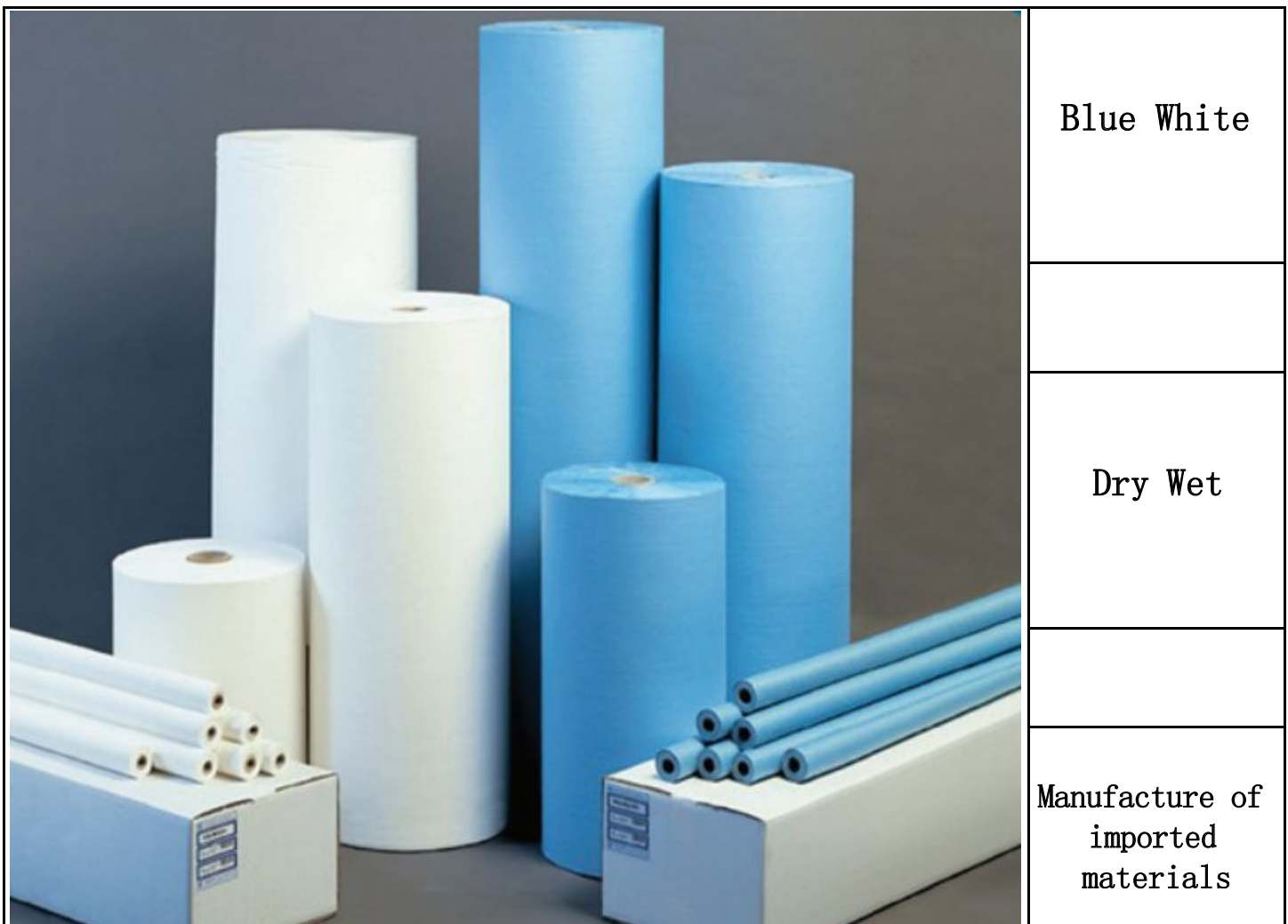

Blue White

Dry Wet

Manufacture of imported materials





washup-cloth for heidelberg roland komori KBA MIS and ryboi

shaft ID X shaft OD X Shaft length-Cloth width X Cloth length



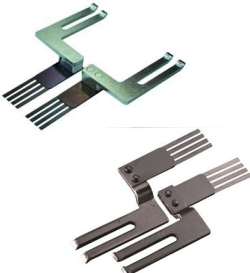

STILGRAFIC

				
C5. 028. 075F	G2. 028. 096S/08	C5. 016. 661S/01	C5. 028. 210/01	G2. 028. 095S

				
41. 028. 151	41. 028. 008/02	Carrierair blower	F2. 028. 446	F2. 028. 476S

				
66. 028. 110F/810F	L4. 028. 165S/164S	L4. 028. 167S/168S	M3. 028. 824S/01	Separator finger





				
66. 028. 109F	66. 072. 089F/06	M3. 028. 825S	41. 028. 046F/056F	MV. 103. 290/291

				
F2. 028. 187	MV. 030. 574/03	66. 028. 411F	MV. 053. 960/02	F2. 028. 160S/170S



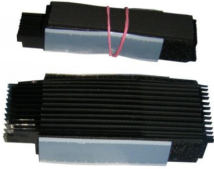

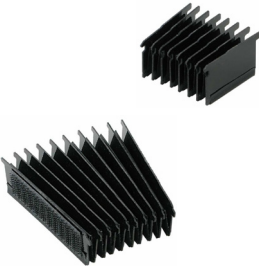
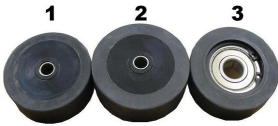
STILGRAFIC

				
66.028.809/01	66.028.409	66.028.009/01	C4.028.009/02	MV.056.999

				
F2.028.280S	F2.028.276S	MV.005.247 /01	MV.005.433 /01	G2.072.073/059



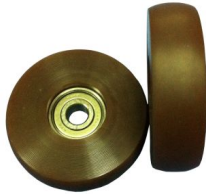

				
F2.072.140	SA.072.144	L2.072.324	C6.020.170F/01	roller

				
41.016.270F	MV.037.921	66.891.006	66.020.122	MV.051.122/01

				
MV.015.693/01	C6.020.125F	Additional rol	roller with bear	C5.016.276F/04

STILGRAFIC

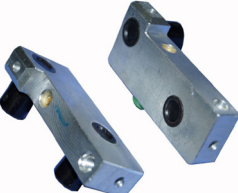
				
F2. 028. 260/270	66. 028. 046F/056F	C5. 028. 005F/05	GTO sucker	41. 028. 409/03

				
F2. 028. 182S	F2. 028. 162S	MV. 026. 788	86. 020. 004F/005F	MV. 018. 110

				
00. 550. 0670	00. 550. 1307	52048	F-29260	F-57439. 02

				
00. 580. 5612	LR6000-2RS	00. 550. 1807	F-226335. N4U	F-82770

				
F-51380	F-42446	F-209892	F-34097	F-233282. 01

				
F-229818	Cross Roller	00. 550. 0675	00. 550. 1505	F-213584

				
F-229817	00. 550. 0251	F-87592	F-218220	00 550 0977

				
F-4346. 01	F-217813. 4	00. 520. 1682	F-53125. 02	00. 550. 0462

				
SP5670	01. 002. 061	F-83518	FE448	00. 550. 0648

				
F-94474. 01	FFW2025	00. 550. 0542	F2. 011. 121/01	cam follower

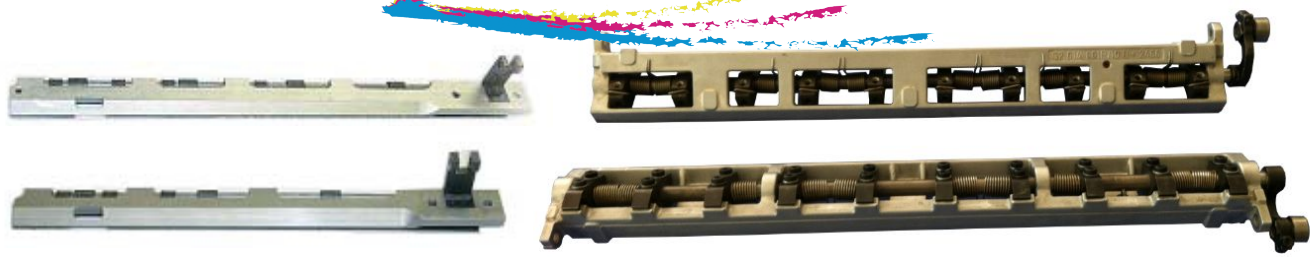

GT/T Gripper bar L=440 L=353 SM/PM52 Gripper bar G2.014.001F/10



CD102/SM102 Gripper bar completer



SM74 / PM 74 Gripper bar M2.014.003S



MV.031.526/01 Transfer gripper bar



XL75/CD74 Gripper bar L4.014.001F







SM102/CD102 delivery gripper bar MV.006.506



				
66.028.015R	G2.010.209/210	69.013.044/22	43.022.111	MV.032.569



				
G2.015.513F	MV.025.596/05	MV.016.094/03	M2.033.571	93.015.350F/04

				
71.030.246	MV.016.611	MV.036.786	82.008.134F	Clutch plate

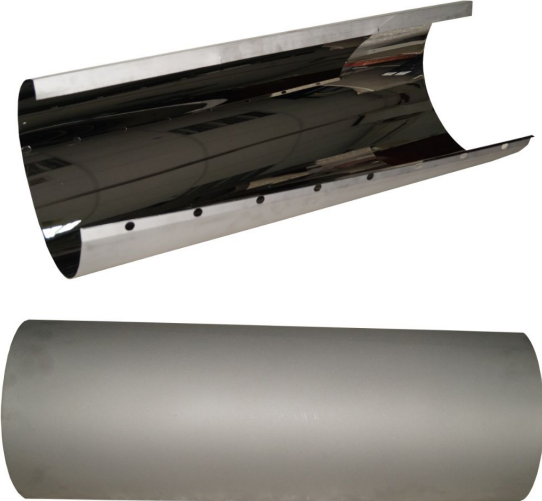
				
C8.030.272/273	G2.029.301F	C6.014.039/06	m2.148.1041	F2.148.1041

		
<p>GTO 42.030.375</p>	<p>82.008.005F</p>	
		<p>HEIDELBER CD102/SM102 TRANSFER CYLINDER JACKET</p>
<p>41.008.005F</p>	<p>91.008.005F</p>	



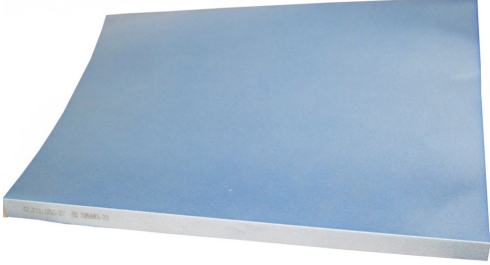

	
<p>SM/PM 74 transfer cylinder jacket</p>	<p>XL75 Sheet guide L2.805.520S</p>

		
<p>MV.058.851/01</p>	<p>SM52 Metering roller cpl G2.030.310F/08</p>	<p>SM/PM 52 transfer cylinder jacket</p>

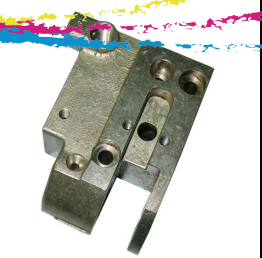

 <p>00.580.4473/03 Clamp L=511 mm</p>				 <p>clamp plate Chuck</p>
 <p>00.580.4128/03 SM74/CD74Clamp</p>				 <p>00.580.3961</p>
 <p>00.580.4129/03 102 - Clamp (996mm)</p>				 <p>Gas nozzle</p>
 <p>87.334.017 /01 Clamp (1049mm)</p>				
00.580.4473	00.580.4128	00.580.4129	87.334.017/01	

 <p>CD102/SM102 PS plate bar</p>	 <p>M2.013.158</p>	 <p>41.458.725/A</p>	 <p>C5.006.431</p>
---	---	---	---

STILGRAFIC



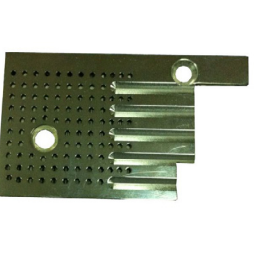
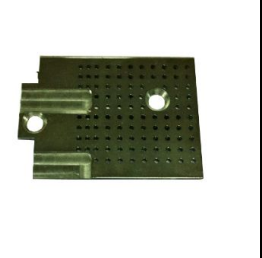
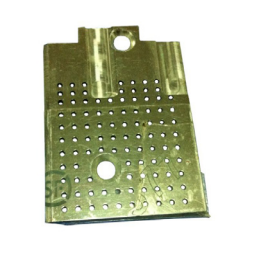

				
side lay complete	C5.072.202/04	C5.072.201/04	C5.072.205/206	L2.072.120/220

				
MV.003.966	C5.072.207/227	C5.072.605	66.016.233	C5.016.232

				
L2.072.239/04	L2.072.139/03	L2.072.114	L2.072.214	L2.072.210S

				
G2.022.230S	71010044S/046s/048s/047S	C5.020.018	C5.020.020	MV.026.847

				
C5.028.302F	71.010.013	71.010.231/01	MV.037.327	G6.010.063/07

				
C3.011.129/130	82.010.204S	71.010.114/116	Journal box	66.006.029/031

				
MV.031.446	42.020.030F	63.030.538	C6.015.701/702	00.580.0189

				
MV.051.118	73.010.085	C3.011.128F	71.010.020F	52.007.085

				
SA.072.002	66.030.006	00.580.2807	00.580.3968	00.580.6691

				
91.010.322S/323	MV.015.912/02	71.010.308/310	71.030.205	C4.101.3023/02











STILGRAFIE





PLATINUM → 0.5 .020" ↓ 0.40/.016" ↑	50 to 100	APPLE GREEN → 1.5 .060" ↓ 0.45/.018" ↑	260 to 300	TANGERINE → 2.3 .090" ↓ 0.60/.024" ↑	400 to 465	LIGHT OAK → 3.2 .126" ↓ 0.70/.028" ↑	550 to 675
DAFFODIL → 0.6 .024" ↓ 0.30/.012" ↑	50 to 100	YELLOW → 1.5 .060" ↓ 0.50/.020" ↑	290 to 335	RED → 2.3 .090" ↓ 0.70/.028" ↑	420 to 465	LEAF → 3.2 .126" ↓ 0.80/.032" ↑	560 to 685
FIRE → 0.6 .024" ↓ 0.40/.016" ↑	50 to 100	FUCHSIA → 1.5 .060" ↓ 0.55/.022" ↑	300 to 335	LEMON → 2.3 .090" ↓ 0.80/.032" ↑	450 to 500	VIOLET → 3.2 .126" ↓ 1.00/.040" ↑	560 to 685
ALPINE → 0.8 .032" ↓ 0.30/.012" ↑	50 to 100	NAVY BLUE → 1.5 .060" ↓ 0.60/.024" ↑	300 to 335	BLUEBELL → 2.3 .090" ↓ 1.00/.040" ↑	450 to 500	FUDGE → 3.2 .126" ↓ 1.20/.048" ↑	560 to 685
ORANGE → 0.8 .032" ↓ 0.40/.016" ↑	50 to 150	ROSEWOOD → 1.5 .060" ↓ 0.70/.028" ↑	350 to 365	RACING GREEN → 2.5 .099" ↓ 0.60/.024" ↑	460 to 500	TOPAZ → 3.5 .138" ↓ 0.60/.024" ↑	570 to 695
ROYAL BLUE → 0.8 .032" ↓ 0.45/.018" ↑	60 to 160	RUBY → 1.5 .060" ↓ 0.80/.032" ↑	350 to 365	DUSK → 2.5 .099" ↓ 0.70/.028" ↑	460 to 500	BOTTLE GREEN → 3.5 .138" ↓ 0.70/.028" ↑	570 to 695
BLUEBERRY → 1.0 .040" ↓ 0.30/.012" ↑	60 to 160	HOLLY → 1.6 .063" ↓ 0.40/.016" ↑	360 to 370	MANILLA → 2.5 .099" ↓ 0.80/.032" ↑	460 to 500	MARINE BLUE → 3.5 .138" ↓ 0.80/.032" ↑	580 to 700
BEIGE → 1.0 .040" ↓ 0.40/.016" ↑	100 to 175	CORNFLOWER → 1.6 .063" ↓ 0.50/.020" ↑	360 to 370	LIME → 2.7 .106" ↓ 0.40/.016" ↑	460 to 500	BLUSH → 3.5 .138" ↓ 1.00/.040" ↑	580 to 700
PEACH → 1.0 .040" ↓ 0.50/.020" ↑	165 to 190	SPEARMINT → 1.6 .063" ↓ 0.60/.024" ↑	360 to 370	SAND → 2.7 .106" ↓ 0.60/.024" ↑	460 to 500	CORNELIAN → 4.0 .158" ↓ 0.80/.032" ↑	620 to 735
LIGHT PINK → 1.2 .048" ↓ 0.30/.012" ↑	170 to 195	LAVENDER → 1.6 .063" ↓ 0.80/.032" ↑	360 to 370	PEPPERMINT → 2.7 .106" ↓ 0.70/.028" ↑	460 to 500	CYCLAMEN → 4.0 .158" ↓ 0.90/.036" ↑	630 to 740
LILAC → 1.2 .048" ↓ 0.40/.016" ↑	150 to 200	MOONSTONE → 1.7 .065" ↓ 0.30/.012" ↑	360 to 370	BLUE → 2.7 .106" ↓ 0.80/.032" ↑	460 to 500	CARNIVAL RED → 4.0 .158" ↓ 1.00/.040" ↑	650 to 790
IVORY → 1.2 .048" ↓ 0.45/.018" ↑	185 to 225	VANILLA → 1.7 .068" ↓ 0.40/.016" ↑	360 to 370	POLAR WHITE → 2.7 .106" ↓ 1.00/.040" ↑	475 to 550	GREY → 4.0 .158" ↓ 1.20/.046" ↑	665 to 800
OLIVE → 1.2 .048" ↓ 0.50/.020" ↑	210 to 240	AVOCADO → 1.7 .068" ↓ 0.50/.020" ↑	350 to 375	HONEYSUCKLE → 3.0 .118" ↓ 0.60/.024" ↑	485 to 565	AMBER → 5.0 .197" ↓ 0.80/.032" ↑	620 to 735
ROSE PINK → 1.3 .052" ↓ 0.30/.012" ↑	210 to 240	POWDER BLUE → 1.7 .068" ↓ 0.55/.022" ↑	350 to 375	ONYX → 3.0 .118" ↓ 0.70/.028" ↑	485 to 565	SUNFLOWER → 5.0 .197" ↓ 1.00/.040" ↑	650 to 790
PALE BLUE → 1.3 .052" ↓ 0.40/.016" ↑	225 to 275	PURPLE → 1.7 .068" ↓ 0.60/.024" ↑	350 to 400	NASTURTIUM → 3.0 .118" ↓ 0.80/.032" ↑	490 to 575	BLACK → 5.0 .197" ↓ 1.50/.060" ↑	650 to 790
WHITE → 1.3 .052" ↓ 0.45/.018" ↑	240 to 270	CINNAMON → 1.7 .068" ↓ 0.70/.028" ↑	350 to 375	BROWN → 3.0 .118" ↓ 1.00/.040" ↑	535 to 665	COCONUT → 6.0 .236" ↓ 0.80/.032" ↑	650 to 790
BRIGHT GREEN → 1.3 .052" ↓ 0.50/.020" ↑	240 to 290	PACIFIC BLUE → 1.7 .068" ↓ 0.80/.032" ↑	350 to 400	PISTACHIO → 3.0 .118" ↓ 1.40/.056" ↑	550 to 675	COBALT BLUE → 6.0 .236" ↓ 1.00/.040" ↑	910 to 990
BLACK → 1.3 .052" ↓ 0.55/.022" ↑	240 to 300	MUSTARD → 1.9 .075" ↓ 0.40/.016" ↑	350 to 400	CANARY → 3.2 .126" ↓ 0.60/.024" ↑	550 to 675	CREAM → 6.0 .236" ↓ 1.70/.068" ↑	900 to 1000
AUBERGINE → 1.3 .055" ↓ 0.60/.024" ↑	240 to 290	ICE BLUE → 1.9 .075" ↓ 0.50/.020" ↑	350 to 400				
SHERBET → 1.3 .055" ↓ 0.70/.028" ↑	240 to 290	GREEN → 1.9 .075" ↓ 0.60/.024" ↑	350 to 400				
TITANIUM → 1.4 .055" ↓ 0.30/.012" ↑	240 to 290	COFFEE → 1.9 .075" ↓ 0.70/.028" ↑	360 to 400				
OCEAN → 1.4 .055" ↓ 0.40/.016" ↑	240 to 290	ASH GREY → 1.9 .075" ↓ 0.80/.032" ↑	365 to 400				
TOFFEE → 1.4 .055" ↓ 0.45/.018" ↑	240 to 290	EBONY → 2.1 .083" ↓ 0.50/.020" ↑	375 to 410				
TERRACOTTA → 1.4 .055" ↓ 0.50/.020" ↑	240 to 290	DIAMOND WHITE → 2.1 .083" ↓ 0.60/.024" ↑	385 to 435				
LAGOON → 1.4 .055" ↓ 0.55/.022" ↑	240 to 290	BURGUNDY → 2.1 .083" ↓ 0.65/.026" ↑	385 to 435				
LIGHT ORANGE → 1.5 .060" ↓ 0.30/.012" ↑	250 to 300	SANDSTONE → 2.1 .083" ↓ 0.70/.028" ↑	385 to 435				
FLAME → 1.5 .060" ↓ 0.40/.016" ↑	250 to 300	PINK → 2.1 .083" ↓ 0.80/.032" ↑	400 to 465				







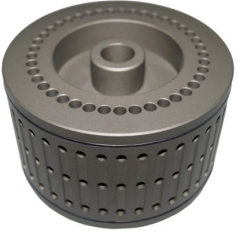



STILGRAFIC

				
ZD. 212-806-01-00	ZD. 224-921-0100	ZD. 204-268-BG-03	ZD. 203-764-01-00	226-337-BG-02



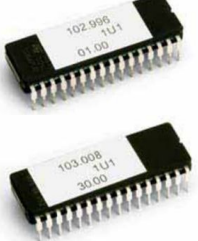

				
219-733-BG01	889. 0726. 4	ZD-235-125-0200	FH. 1075231/01	Plate clamp levers

				
ZA3. 017771	ZD. 245-500-0100	ZD. 200-634-02-00	233-002-0100	233-028-0100

				
Footswitch	438612	polar display	polar touchscreen	MBO roller CPL

				
ZA. 033678	0052. 6312	STAHL Roller CPL	Cutting Stick	FH. 1161145/00

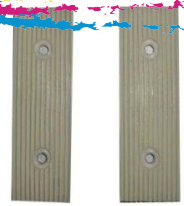
STILGRAFIC

				
1580. 2265. 3	3050. 8950. 4	kelbus	3210. 2203. 3	3210. 2320. 9





				
3690. 1202	0881. 0325. 4	0881. 0010. 4	0235. 1156. 3	0235. 1302. 2

				
3210. 1344. 3	3200. 2223. 3	3210. 1615. 2	3671. 1325. 4B	0890. 1007. 3

				
223840	Kolbus Roller	00844001	277-175-01-00	0020. 1909

				
0888. 0115	Chain buckle	890. 1527. 3	Steel Brush	Driver

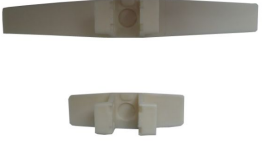



STILGRAFIC

				
1550.5511.3	02-8-737	0210.0616.4	0235.1302	FJ.3200650/01



				
0890.0538.3	890.1526.3	215-477-0200	1550.5510.3	069493

				
G.970138	Transporter Link	ZD.2241-827-0700	1529.1003.4	0896.1108.4

				
Nitrogen bottle	M2000 Head	03-1-556	SIG PUSHER	ZD.023-001-VG-00

				
ZD.2144-095-0100	ZD.2144-238-0100	313-882	MBO MARBLE CUP	ScrewM8*6/M8*8

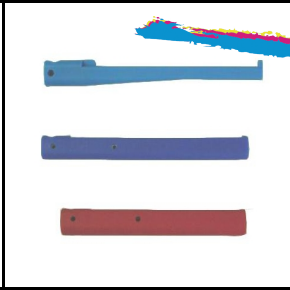
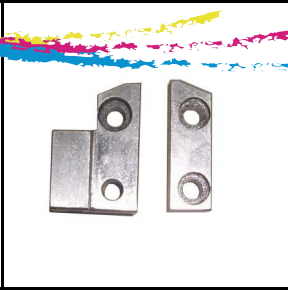
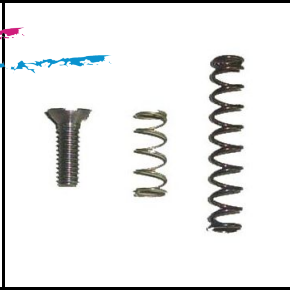
STILGRAFIC

				
3646. 1678. 2	3680. 3597. 2	0881. 0015/6. 4	0030. 9016	220-098-01/02

			 0881.0123.4(老款) 0881.0351.3(碳钢)	
0881. 0042. 4	0881. 0011. 4	1529. 1004	0881. 0351. 3	0881. 0031. 3





				 0881.0368.3 0881.4000.2
1580. 1275. 4	0249. 1074. 4	3210. 3542. 2	0249. 1050. 3	0881. 4000. 2

				 0681.0197.4 0881.0198.4
0881. 0017. 4	0881. 0006. 4.	0881. 0018. 4	0881. 0007. 4	0881. 0197. 4

 0881.4022.3 0881.4212.3			 HK45中刀 HK75中刀(新款) HK75中刀(老款)	
0881. 4022. 3	0881. 0330. 4	0881. 0037. 4	0881. 0326. 3	stitching head



STILGRAFIC

				
ZD. 2144-240-0100	ZD. 2144-241-0100	ZD. 2144-242-0100	ZD. 2144-243-0100	FJ. 4180251/01





				
ZD. 2144-778-0100	ZD. 2245-641-0100	ZD. 278-336-0100	ZD. 278-434-0100	ZD. 2241-828-0100

				
ZD. 278-335-0100	ZD. 278-827-0100	ZD. 277-175-0100	008. 72-0903. 1/1	ZD. 2242-047-0100





				
ZD. 2151-263-0100	ZD. 2151-264-0100	FJ. 1150101/01	FJ. 4288205/00	FJ. 4288215/00





				
ZD. 2142-402-0100	ZD. 2142-666-0100	ZD. 2142-955-0100	ZD. 2163-929-BG-01	ZD. 2163-920-BG-01

STILGRAFIC

				
ZD. 2274-0058-0900	ZD. 2273-002-2000	ZD. 2273-002-2200	ZD. 2273-002-0300	ZD. 203-681-0300

				
FM. 2024350/01	FM. 2023580/02	FM. 2024350/01	ZD. 40102140	FJ. 0590003/00

				
FJ. 0590002/00	ZD. 2123-812-BG01	ZD. 44502074	ZD. 2142-469-0100	ZD. 2242-035-0200

				
ZD. 2241-226-0300	ZD. 2242-053-0100	ZD. 2245-936-1500	ZD. 284-996-0100	ZD. 236-942-BE03

				
FH. 1058061/03	FH. 1059871/02	FH. 1122961/01	231-694/5-0100	ZD. 215-006-0100

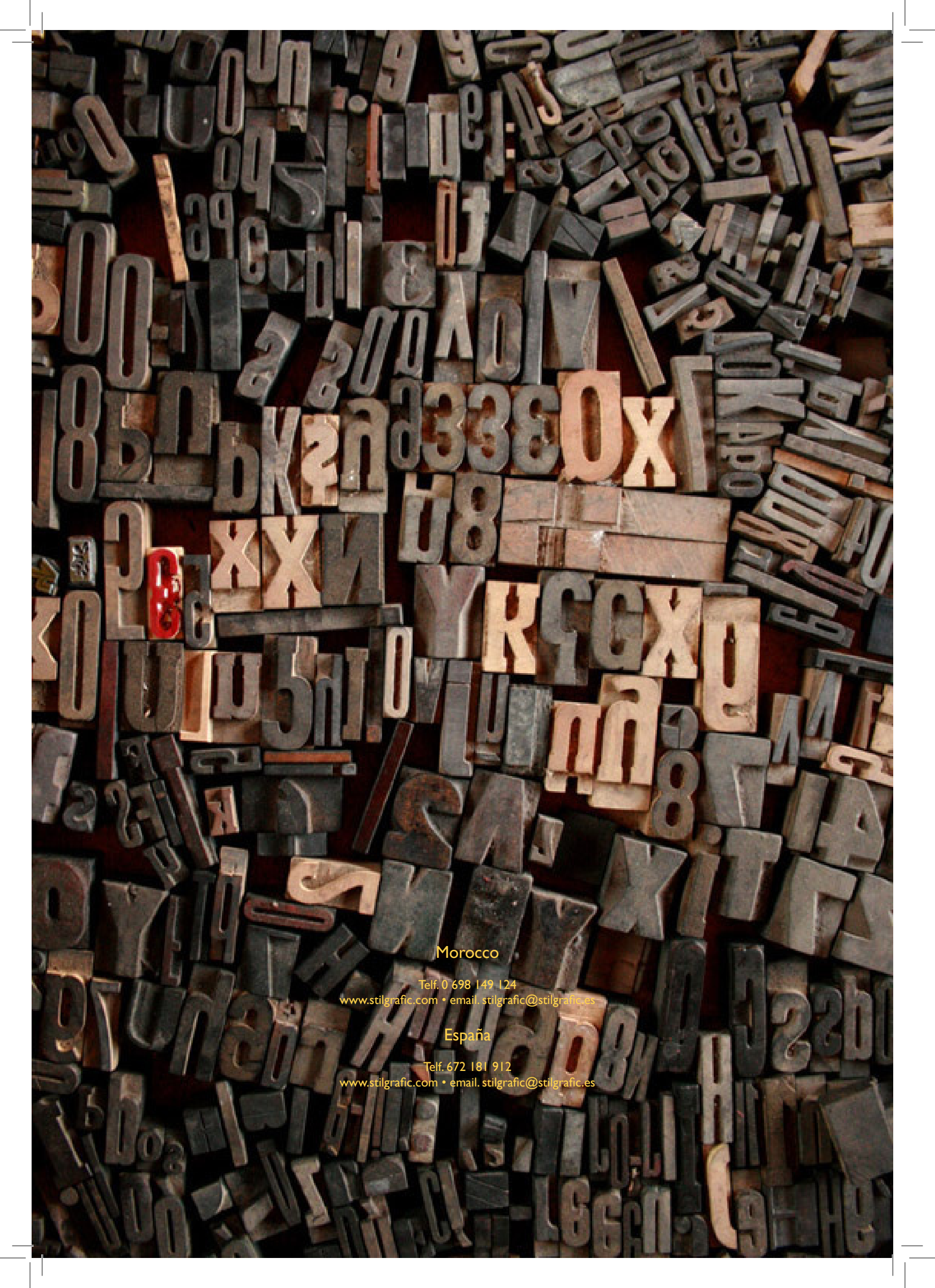

Morocco

Tel. 0 698 149 124

www.stilgrafic.com • email. stilgrafic@stilgrafic.es

España

Tel. 672 181 912

www.stilgrafic.com • email. stilgrafic@stilgrafic.es